

Contact author: Marcos Sanchez, marcos.sanchez@arup.com

Mary Elmes, Design and Construction of an urban pedestrian bridge over river Lee in Cork City Centre. From competition to opening

Authors: Marcos SANCHEZ¹, Simon ROBERTS², Robert RYAN³

Affiliation: ¹ ARUP, Dublin, Ireland

² Wilkinson Eyre, London, UK

³ ARUP, Cork, Ireland

Mary Elmes Bridge is a 66m single span Pedestrian and Cyclist bridge opening in Cork, Ireland in July 2019. In September 2016, Cork City Council launched a competition for a single span – no supports in the river were allowed- pedestrian crossing over the River Lee between the historic bridges of St. Patrick's (a stone arch from 1860's) and Brian Boru (a former rolling bascule from 1920). The competition was launched as part of Cork City Councils key objective to encourage greater sustainable travel in the form of walking and cycling within the city Centre.

Constrained by heavy trafficked quay roads, the design of a single span 66m crossing was a real challenge when taking into account that the flooding level for the 200years return is 400mm higher than the existing footpaths. The winning solution is a slender, steel shallow through beam with a slight arching effect. The main span is fully integral with the abutments with the central steel box girder and variable width cantilevered walkways joining at both landing points to a stiff concrete piled foundations. The concept adopts a clever strategy to integrate at grade landings with existing footpath levels while making the structure compatible with future city flood defenses. The use of the pedestrian walkway as a flange in the longitudinal direction allows the structure to achieve a significant slenderness.

This proposal establishes a connective dialogue with its surrounds and compliant with challenging flooding and visual requirements.

Keywords: urban bridges, conceptual design, slender bridges, dynamics.



Fig. 1. Morning View from Nearby Brian Boru Bridge

1. Introduction

The competition, won by ARUP Ireland and Wilkinson Eyre, proposed a shallow slender spine beam fully constrained at the abutments which are hidden behind the quay walls by means of a concrete pilecap and two rows of piles provide stiffness to the structural system. The steel beam, with a L/42 slenderness ratio at midspan and L/36 at supports, takes advantage of the arching effect by varying its vertical position relative to the pedestrian walkway and membrane contribution of the steel plate of the transversal cantilevers which are both an integral part of the structural system and the architectural personality of the bridge. The slenderness achieved required a significant analysis effort combining static, construction and dynamic analysis. The

architectural illumination and the integration of the railing into the bridge appearance were also considered carefully, allowing the bridge to express its own personality without overshadowing the existing historic bridges. With a curved geometry both in plan and elevation and a careful consideration of its urban placing, not only as a crossing but as a place, the bridge has been extremely successful since opening in July 2019, enjoyed by pedestrians, cyclists and idlers alike.

2. Concept Design

The competition launched by Cork City council in September 2016 requested a low level, single span pedestrian/cycle bridge crossing the River Lee between the historic St.Patrick's bridge (the oldest crossing in Cork) and Brian Boru bridges (a 1911 rolling bascule retrofitted as a fixed bridge).

The requirements to avoid supports in the water clearly pushed for a single span over 60m, a minimum walking width of 4.5m for pedestrian and flooding levels higher than the landing points required a structural system where the deck under the walking level was minimal. This proved challenging, particularly in the context of a constrained landing points, with heavily trafficked roads on both quays and relatively narrow foot paths.

The initial concept focused on a central steel beam (see figure 2), this cross section resolves well the midspan section although it divides the pedestrian-cycle area in two parts. However, this cross section is less successful at the landing points: if the central beam is kept higher than the walking level it will block the pedestrian movements along the quays unless the structure is simply supported, which is very inefficient structurally.

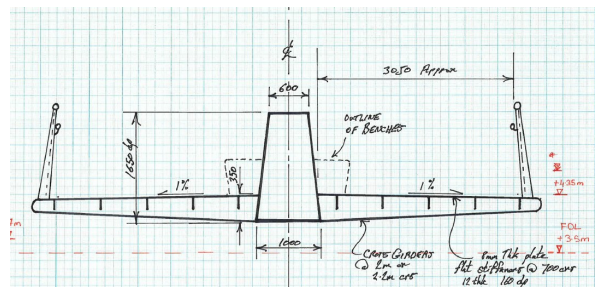

Fig. 2. Conceptual Cross Section at Midspan

In order to resolve this problem, the central spine beam was lowered at both ends providing both an arching effect in the longitudinal behavior and also allowed to provide rotational stiffness of the deck under live load by constraining the rotations to the pilecap. This approach, combined with the contribution of the walking path as a membrane/flange in the longitudinal direction, allowed to achieve a very slender solution.

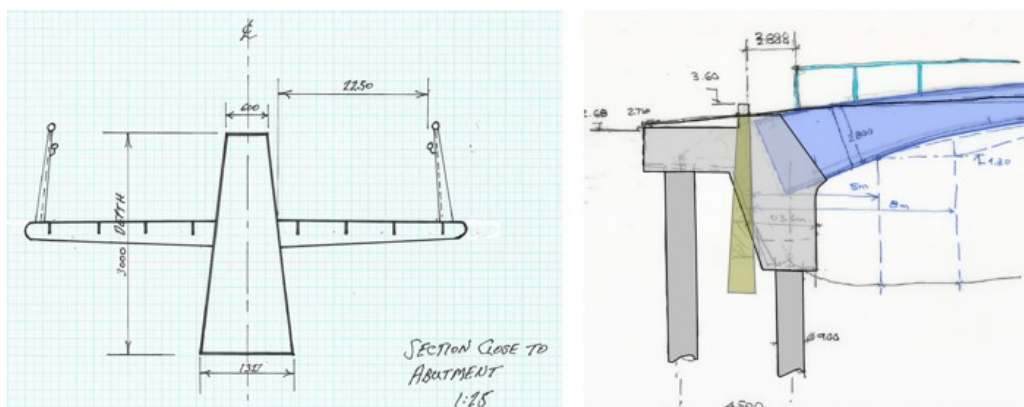

Fig. 3. Conceptual Cross Section at supports

2.1 Flooding Constraints

The bridge needed to land in existing masonry quay walls, built in the 19th century of bonded rubble masonry and faced with 0.6m average cut limestone blocks. With a requirement to tie in with the city's future flood protection scheme the minimum un-protected tie in level needed to be above +3.6mOD, 0.85m above the existing footpath level. To achieve a tie in point that could be practically accessed without excessive ramps while spanning the watercourse without negatively impacting on the hydraulic characteristics under a 1/100 year fluvial and 1/200 year tidal flood event, an hybrid solution was proposed.

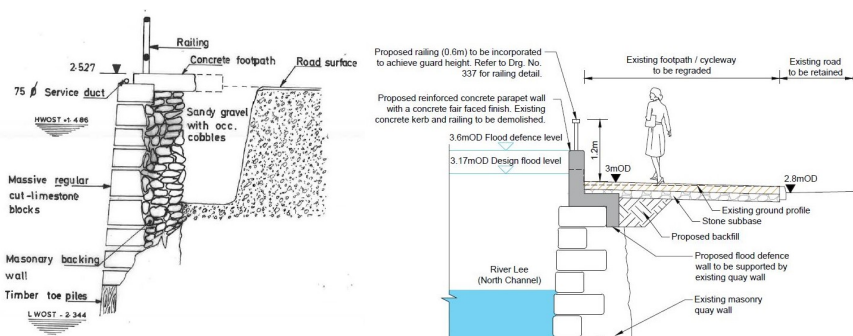

Fig. 4. Cross Section of Existing Quay Walls and Proposed Flood Levels at Landings

The solution chosen adopted a tie in level that requires an active flood protection measures to address the flooding levels for the L/100 and L/200 but not for the L/50 return period. By setting the bridge tie in level at the maximum design flood level of +3.17mOD and maintaining a maximum ramp gradient of 5%, a retractable flood protection gate was specified to protect against the remaining flood level arising from climate change.

Setting the bridge deck level at or above the design flood level and transitioning the structure from below to above the deck over the length of the span the impact of the bridge structure on the hydraulic characteristics of the watercourse was minimized.

2.2 Structural System

In order to span 66m without supports, a significant depth or other type of support system (an arch, or a truss) will required. The proposed structural system combined three structural behaviours, the arching effect of the main central beam, the stiffening provided by the walking paths acting as a flange and two stiff abutments with two rows of piles hidden behind the quays which constrained the main span against rotation, acting effectively as a buried portal frame.

The beam is at its highest at midspan, lowering along the length and going under the walkway at supports, which are integral with the beam. With this configuration the walkways acting as a flange are in tension at midspan under sagging moments and at supports under hogging moments, providing an efficient response without requiring significant longitudinal stiffening.

In addition to the main flexural behaviour, the small arching effect of the central spine beam helps to increase the stiffness of the system. The transition of the central spine beam to below deck and connection of the spine beam and walkway deck to a fully integral abutment with two rows of piles creates a system that behaves as a fully constrained beam in service allowing for an increase in slenderness.

2.3 Abutment and Quay Integration

A key consideration in the concept design of the abutments was minimising the impact of construction on the existing quay walls and allowing the contractor the flexibility to construct the abutments in advance of final bridge steelwork fabrication. 6 no. 900mm diameter bored piles in two rows were chosen to ensure minimal lateral load transfer to the quay walls and adequate stiffening of the main span.

3. Detailed Design

3.1 Bridge Geometry

The final geometry of the bridge is quite complex in definition. While the axis of the central spine beam is straight in plan, it is curved in elevation, and any other parameter defining the cross-section results from the intersection of cylinders in 3D producing a curved variation of the width in plan and elevation of every structural element (top and bottom flanges of the spine beam and walking flanges).

The walkway surface was set out using varying radii arcs tangential to a maximum walkway gradient of 5%. The top and bottom flanges of the main spine beam were then set out by a maximum offset from the walkway at midspan and an intersection point with the walkway 2m from the quay wall face. This resulted in a difference in depth of the central spine beam of 1.6m at midspan and 2.0m at supports.

The plan curvature of the spine beam was then generated by projecting the top and bottom flange onto the surface of inclined cylinders. Thus, the top and bottom flanges have significant variation in width as their projection onto the inclined cylinders transitions in a three-dimensional curve towards the abutments.

The walking areas also vary in width, being wider at midspan, where seating is provided using the beam as a resting wall, and narrower at supports merging to a single width as the beam transitions under the walking platform. The three-dimensional curvature and absence of straight lines provides the bridge with a distinctive shape from every angle and enhances the slenderness appearance and dynamism of the structure.

Figure 5 below, summarizes the main geometric features of the bridge.

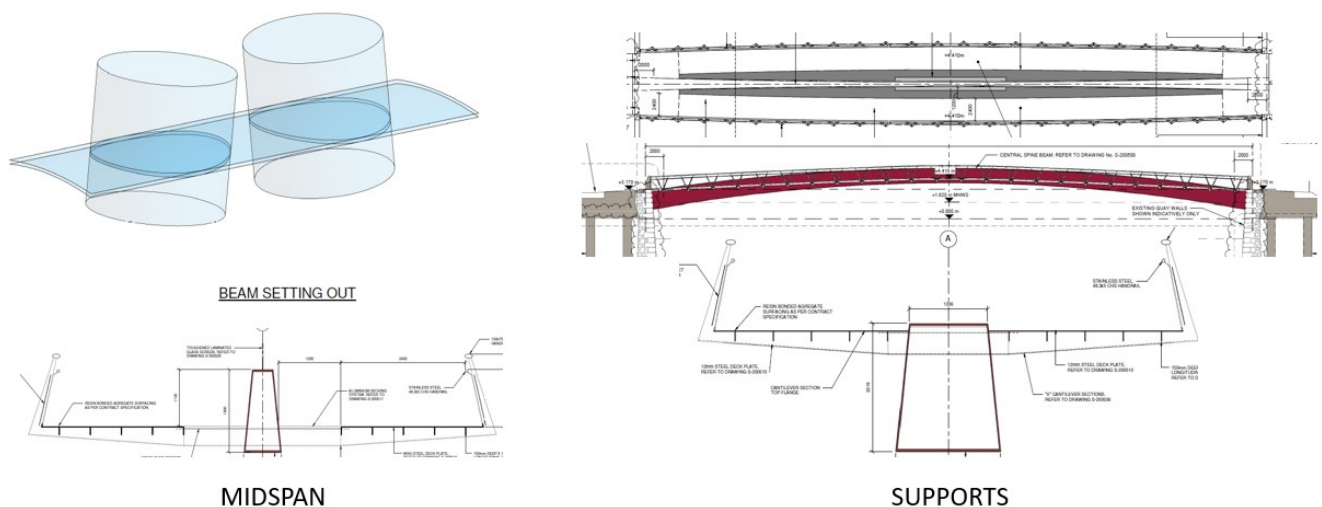

Fig. 5. Geometric principles of the bridge geometry. Plan, elevation, and cross section at midspan and supports.

Using parametric design tools, the original concept was developed to optimise the geometry and deliver the most structurally efficient dimensions while maintaining the visually pleasing shape provided by the different curves and slenderness achieved.

3.2 Global & Static Analysis

As indicated in the previous section, the structure is conceived as a fully constrained structural system during service. Under pedestrian, wind, and thermal loading, the bridge is fully constrained by the provision of two rows of piles and a concrete pile-cap.

The central box varies in location relative to the pedestrian path but also in width as it follows the large radius cylinders. This variation in box size increases the transfer of bending moments at supports. The plate dimensions of the main beam in the final design were as per Table 1 below. These dimensions were the result of the refinement and iterations in the analysis combining the static and dynamic criteria while trying to achieve a structure as slender as possible both in elevation and at midspan in plan.

The global behaviour in service, combines a diaphragm effect of the 10mm thick walkway contributing as flanges with a small arching effect which helps to reduce the predominant bending in the main box girder.

Location		Plate dimensions (bxt)	Location		Plate dimensions (bxt)
Midspan	Top Plate	400x50mm	Supports	Top Plate	1190x40mm
	Web	1600x16mm		Web	1990x20mm
	Bottom plate	722x30mm		Bottom plate	1600x50mm

Table 1. Main Box Plate Dimensions

As shown in Figure 6 and 7 below, for a fully loaded 5kN/m² unfactored pedestrian load, the system behaves as a fully constrained beam with the hogging moment (-) larger than twice the sagging moment (+). The combined moment in the beam $M_{iso} = 2,544 + 6,537 = 9,081$ kNm directly observed in the spine beam represents only 60% of the global bending under this load.

The rest is accounted for by the the membrane contribution of the pedestrian walkway acting as a tension flange at a variable eccentricity to the beam neutral axis along the span (around 30% of the total bending), with a small fraction (12%) remaining as arching effect of the spine beam due to the curvature in elevation (around 1200kN).

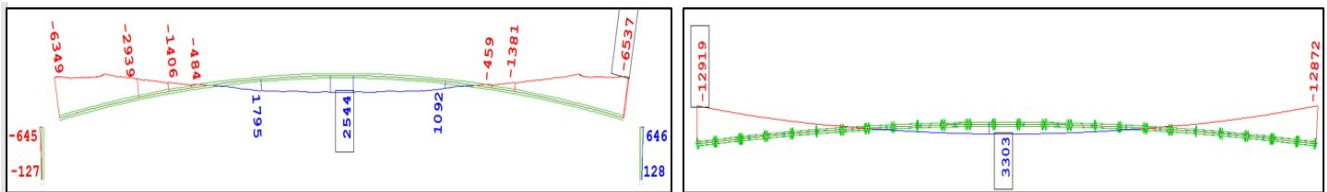

Fig. 6. Main box bending moment under full unfactored pedestrian loading considering the box only (Left) and with the full contribution of the pedestrian walkway (right)

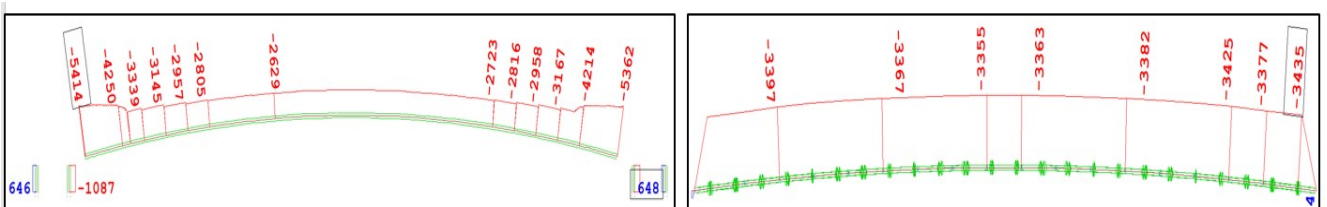

Fig. 7. Main box axial forces under full unfactored pedestrian loading considering the box only (Left) and the contribution of the pedestrian walkway (right)

Due to the curvature in elevation (arching effect) the effects of temperature in the abutments are also lower than those expected in horizontal structure as part of the imposed deformations are taken by the change in shape of the beam and pedestrian walkway.

3.3 Structural Design

3.3.1 Abutment

The abutment consisted of two rows of three piles of 900mm diameter on each abutment. The front row works in compression while the back row works mostly in tension due to the push-pull effect created by the constraint to rotation imposed on the deck. The abutment reinforcement was solved by a series of Strut and Tie models (STM) both in plan and elevation generated in a 3D STM in GSA [1].

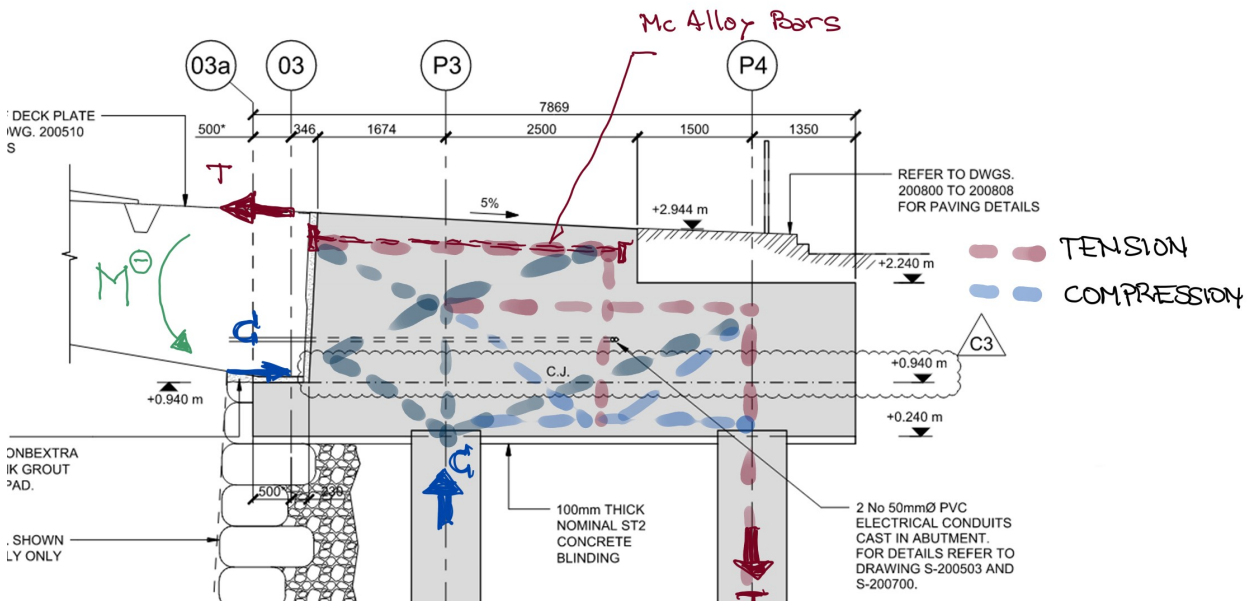

Fig. 8. Abutment Configuration. Structural System

The detailing of the abutment, which needs to transfer the bending moment of the main span into the foundation, required several 3D STM models. This load path was also complicated by the requirement of a step in the abutment to accommodate the services at the kerb line between the footpath and the existing road. The connection of the top flange of the deck to the abutment was achieved by the location of two rows of Macalloy bars, one at each side of the beam.

3.3.2 Walkway flanges & Ribs

The railing and the walking flange are connected to the main beam through a steel rib located every 2.7m, these ribs have a "V" shaped cross section and posed a significant challenge from a structural point of view.

The triangular shape of the ribs, continuing with the inclination of the railing, was very inefficient structurally to resist bending due to the limited capacity of the bottom flange. In addition, the Architectural vision required to incorporate a transparent deck in the pedestrian walkway adjacent to the spine beam which forces the interruption of the walkway, which is acting as an external flange, in its last 300mm closer to the spine beam. At this location, not only the ribs are taking the maximum vertical bending of the walkway as a cantilever, but the void forces the rib to be designed for a significant horizontal shear as the load transfer from the walkway acting as a flange and the main spine beam can only happen through the rib.

The horizontal shear developed due to the axial load transferred from the external flanges to the main beam due to the behavior under global bending makes the ribs work as a Vierendeel beam in plan through the void (See Figure 9 below). The magnitude of the horizontal shear in the ribs closer to the abutments is higher as it follows the global bending shear transfer, which proves the efficiency of the structural system as a tridimensional structure.

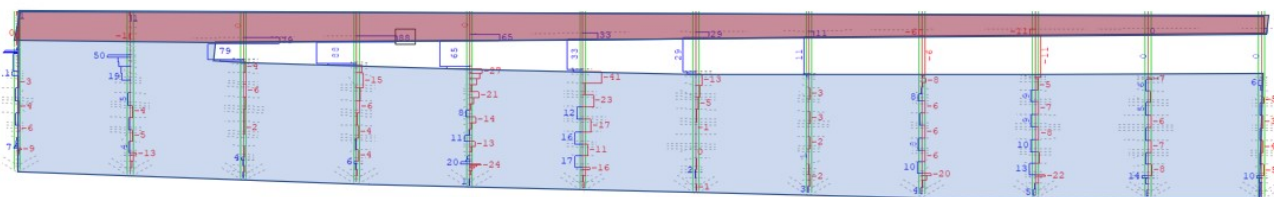

Fig. 9. Horizontal shear in the ribs induced by the global bending (kN) (quarter of a bridge, abutment on the left, midspan on the right). Pedestrian walkway flange shown in blue and central spine beam in red.

It is also important to highlight that the stiffening contribution of the pedestrian walkways under lateral buckling is crucial for the efficiency of the solution, as shown in table 1 above, despite a slenderness at midspan of $L/44$, the top flange of the central box, which is working in compression at this location, is only 400mm wide for a walkway width of 5.5m on average.

3.4 Dynamics

3.4.1 Introduction

As expected from a lightweight slender structure, the dynamic behaviour had a significant influence on the final design of the structure. In this case, the horizontal vibration was not expected to be a problem, however the vertical vibrations needed careful consideration.

The applicable standard, Eurocode 0 [3], requests that if the fundamental frequency is lower than 5Hz for vertical and 2.5 for torsional and horizontal then a comfort criteria verification should be performed, establishing a maximum acceleration for comfort of 0.7m/s^2 for vertical and 0.20 m/s^2 for horizontal.

This criteria is relatively stringent, when compared, for example, with other European sources such as SYNPEX [4] which establishes the following comfort classes, less onerous than the Eurocode limits.

3.4.2 Vibration Modes

Mary Elmes bridge presented 4 modes under 5Hz. As expected, given the transversal rigidity provided by the walking path and the fixity at the abutments, the horizontal modes are much higher than the vertical.



Fig. 10. First Mode 2.8 Hz (Bending)

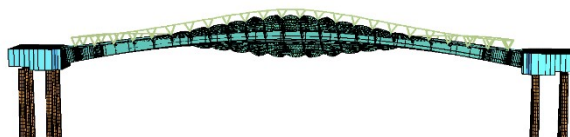

Fig. 11. Second Mode 3.5 Hz (Torsional)

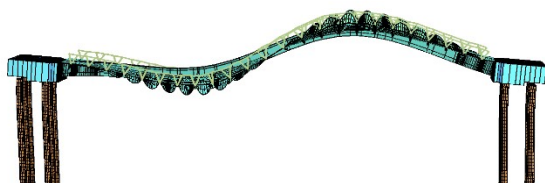

Fig. 12. Third Mode 4.80 Hz (Bending 2)

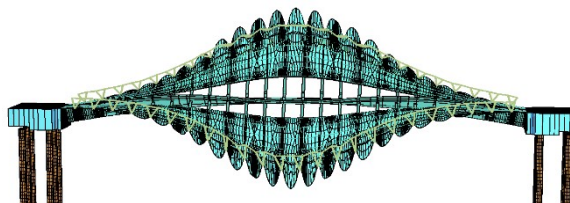

Fig. 13. Fourth Mode 4.82 Hz (Torsion 2)

3.4.3 Pedestrian Footfall Analysis

Further analysis on the pedestrian dynamic behavior was carried out. A new model, using Arup's own house GSA Oasys [1] was performed in order to verify the dynamic behavior of the bridge [5]

Using the loading cases recommended by the Irish National Annex to the Eurocodes [6], the following results were obtained:

Load	Av max center	Av max cantilever
Walker	0.21 m/s^2	0.29 m/s^2
16xWalkers	0.37 m/s^2	0.57 m/s^2
4x joggers	0.87 m/s^2	1.22 m/s^2

Table 2. Max Vertical Accelerations

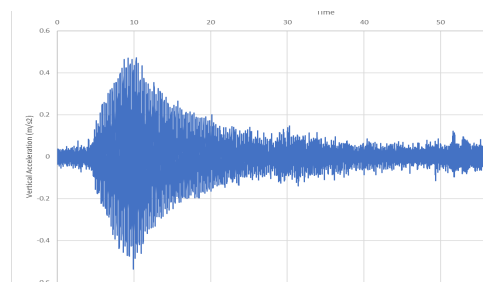

Fig. 14. Acceleration Measurements at Midspan

As the table above shows, measuring the acceleration at the end of the cantilever, the acceleration is larger than the 0.7 m/s^2 only for the 4 joggers load case. This acceleration however is still within the medium

comfort criteria of [3]. For the conventional walking crowd expected on the bridge, the results are well within the medium or maximum comfort criteria. Consequently, no additional dampers were considered as result of the dynamic analysis. These results have been validated with field measurements, which demonstrate the accuracy of the dynamic analysis.

4. Construction

Since the abutments were located behind the existing quay walls, sheet-piling and associated temporary works within the river could be minimized. Temporary traffic management was maintained to minimize the disruption to traffic on the quays with two lanes of traffic maintained at all times. The foundation level is also under the tidal range, which required the installation of a secondary sheetpile to construct the pilecaps.

The bridge steelwork was fabricated in a yard 150km north of the final location and transported in 9 sections to an assembly yard in Cobh within the lower harbour south of Cork City for final assembly.



Fig. 15. Abutment construction and bridge being floated upstream to its final location

It was then floated upstream to its final location using a H shaped custom-built barge with the spine beam semi submerged to reduce the overall depth of the structure in the water. The operation of floating the bridge under the existing bridges was carried out with maximum accuracy since the tolerance between the riverbed and the Brian Boru deck soffit was approximately 400mm. Given the tidal range of the river in this location, a period of 50 minutes was the maximum window available to cross under the existing bridges.

Similarly, the lifting of the bridge into it's final position was also time constrained. This comprised a 2 hour window to complete the lift and secure the landing points both horizontally and vertically due to the tidal range. The bridge was then erected in a single tandem lift using two 750 ton cranes in May, 2019.

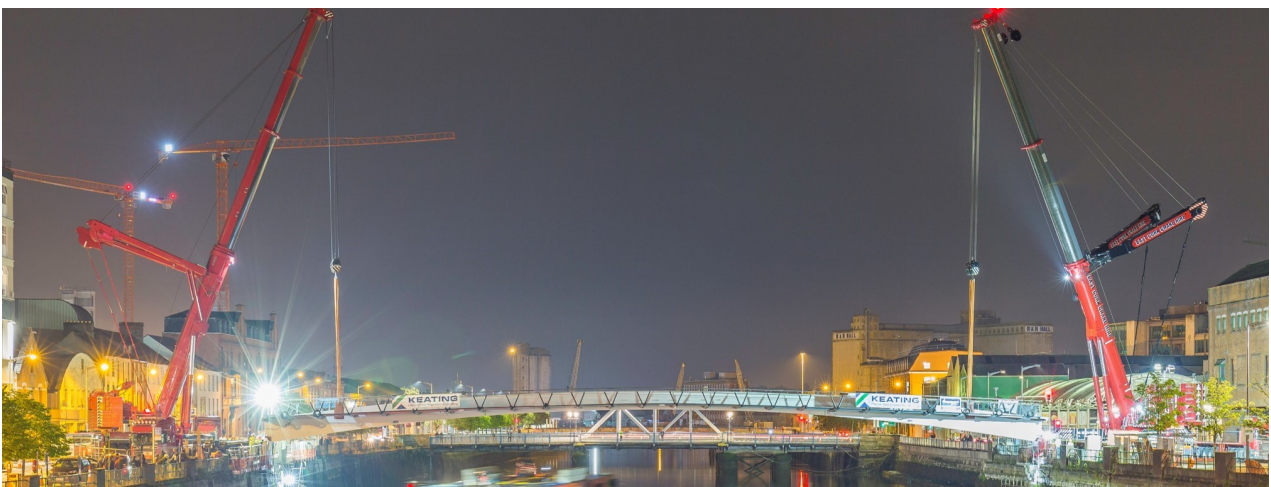

Fig. 16. Crane Tandem erection of the deck.

5. Discussion and Conclusions

The bridge has been extremely successful since its opening in July 2019. One of the noticeable social benefits has been the use of the bridge as a destination with people using the central benches and spine beam as a meeting point to enjoy the river views.



Fig. 17. Bridge View from the pedestrian path



Fig. 18. Bridge and architectural lighting

5.1 Acknowledgements

The Authors want to thank John Stapleton, from Cork City Council who was behind this project from its inception and who's contribution throughout all stages has been paramount to the success of the project. Also, the contribution of the Steel contractor Thomson Steel from Carlow, and the main contractor, Keating Construction who added significant value to the project.

References

- [1] ARUP Oasys GSA version 10.0
- [2] SOFiSTiK 2018 software using input language CADINP, SOFiSTiK Structural Desktop (SSD)
- [3] EN 1990 (2002) Clause A2.4.3.2 Pedestrian comfort criteria (for serviceability)
- [4] Design of Lightweight Footbridges for Human Induced Vibrations. Christoph Heinemeyer, Christiane Butz, Andreas Keil, Mike Schlaich, Arndt Goldack, Stefan Trometer, Mladen Lukić, Bruno Chabrolin, Arnaud Lemaire, Pierre-Olivier Martin, Álvaro Cunha, Elsa Caetano (2009)
- [5] ARUP Oasys GSA Manual 8.7. Section 2.16. Footfall Analysis
- [6] NA to IS EN 1991-2. NA.2.46 Subclause 5.7(3) Definition of dynamic models for pedestrian loads